

Rotational Position Transducer

Precision Potentiometric Output
Ranges: 0-90° to 0-50 Turns
Industrial Grade

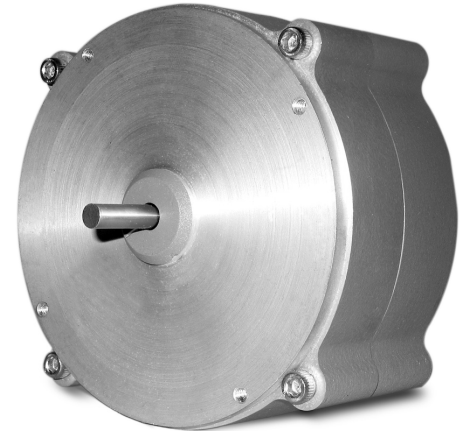

RT9101



Specification Summary:

GENERAL

Full Stroke Range Options 0-0.25 to 0-50 turns
 Output Signal Options voltage divider (potentiometer)
 Accuracy $\pm 0.30\%$ to $\pm 0.15\%$ full stroke *see ordering information*
 Repeatability $\pm 0.02\%$ full stroke
 Resolution essentially infinite
 Enclosure Material Options powder-painted aluminum or stainless steel
 Sensor plastic-hybrid precision potentiometer
 Potentiometer Cycle Life *see ordering information*
 Shaft Loading up to 35 lbs. radial and 5 lbs. axial
 Weight, Aluminum (Stainless Steel) Enclosure 5 lbs. (10 lbs.) max.

ELECTRICAL

Input Resistance Options 500, 1K, 5K, 10K or bridge, *see ordering information*
 Power Rating, Watt 2.0 at 70°F derated to 0 at 250°
 Recommended Maximum Input Voltage 30 V (AC/DC)
 Output Signal Change Over Full Stroke Range 94% $\pm 4\%$ of input voltage

ENVIRONMENTAL

Enclosure NEMA 4/4X/6, IP 67/68
 Operating Temperature -40° to 200°F (-40° to 90°C)
 Vibration up to 10 G's to 2000 Hz maximum

Celesco's model RT9101 provides a voltage feedback signal for rotational position. The sensing element of this device is a precision plastic-hybrid potentiometer which provided superb linearity and resolution.

This innovative sensor from Celesco, designed to meet tough NEMA-4 and IP67 environmental standards, is available in full-stroke measurement ranges of 1/4 to 50 turns. Because the sensor is potentiometric, the RT9101 is absolute and will maintain position information even after a loss of power.

Outline Drawing

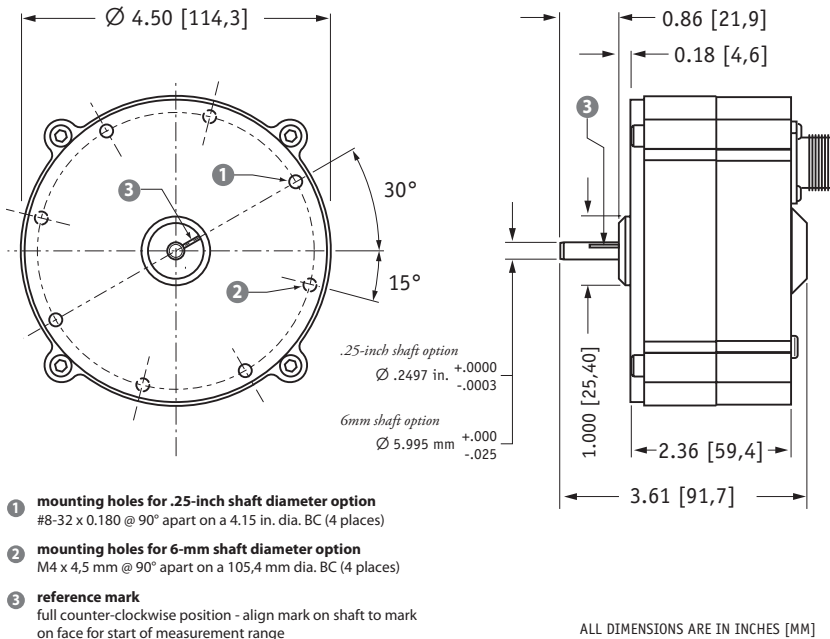

Output Signal

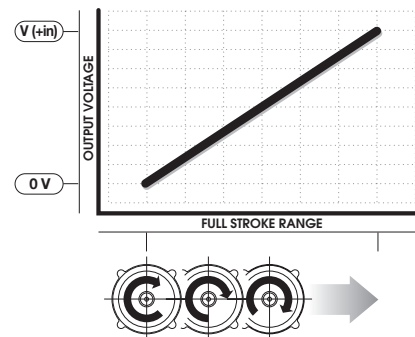

RT9101 • Rotational Transducer: Precision Potentiometric Output

Ordering Information:

Model Number:

RT9101- _____ **-** _____ **1** _____ **1** _____ **0**

order code: **R** **A** **B** **C** **D** **E** **F** **G**

Sample Model Number:

RT9101 - 0005 - 111 - 1110

- R** range: 5 turns (clockwise shaft rotations)
- A** enclosure: aluminum
- B** shaft diameter: .25 inches
- D** output signal: 500 ohm potentiometer
- F** electrical connection: 6-pin plastic connector

Full Stroke Range:



R order code:	0R25	0R50	0001	0002	0003	0005	0010	0020	0030	0050
clockwise shaft rotations, min:	0.25	0.50	1	2	3	5	10	20	30	50
accuracy (% of f.s.):	0.3%	0.3%	0.3%	0.3%	0.3%	0.2%	0.15%	0.15%	0.15%	0.15%
potentiometer cycle life*:	2.5×10^6	2.5×10^6	2.5×10^6	2.5×10^6	2.5×10^6	5×10^5	2.5×10^5	2.5×10^5	2.5×10^5	2.5×10^5

*—number of times the sensor shaft can be cycled back and forth from beginning to end and back to the beginning before any measurable signal degradation may occur.

Enclosure Material:

A order code:	1	2
	powder-painted aluminum	303 stainless steel

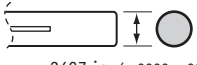
Shaft Diameter:

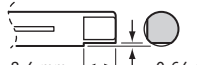
B order code:	1	2	3	4
	0.25-in. diameter	6 mm diameter	0.25-in. dia. w/flats	6 mm dia. w/flats
				
	.2497 in. (+.0000 -0.0003)	5.995 mm (+.000 -0.025)	0.33 in. 0.025 in.	8.4 mm 0.64 mm

Output Signals:

D order code:	1	2	3	4	5
	500 ohm*	1000 ohm*	5000 ohm*	10,000 ohm*	adjustable bridge (0...30 mV/V)
				*tolerance = ±10%	

circuit options: 1, 2, 3, 4

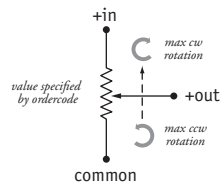



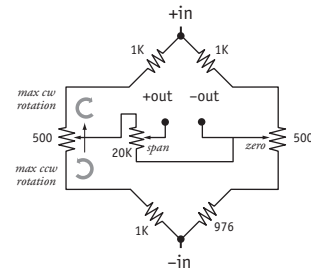

circuit option: 5 (adjustable bridge)

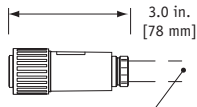
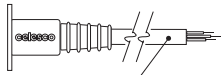
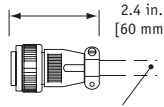

full scale output: adjustable from 0 to 30mV/V
zero adjust: to 50% of full stroke

Ordering Information:

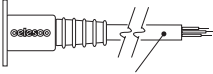
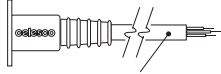
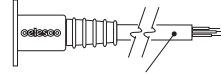
Electrical Connection:

<p>1</p> <p>6-pin plastic connector w/mating plug IP 67, NEMA 4X**, 6</p>  <p>1/2 - 5/16" [14 - 8 mm] cable dia. 16 AWG max conductor size connector: MS3102E-14S-6P mating plug: MS3106E-14S-6S</p>	<p>2</p> <p>10-ft. [3 M] waterproof cable IP 67, NEMA 4X**, 6</p>  <p>10 ft. x 0.4-in. dia. [3 M x 10 mm dia.] 18 AWG, type SJTW</p>	<p>3</p> <p>6-pin metal connector w/mating plug IP 65, NEMA 4</p>  <p>3/8-in. [9 mm] max cable dia. 16 AWG max conductor size connector: MS3102E-14S-6P mating plug: MS3106E-14S-6S</p>	<p>4</p> <p>25-ft. [7.5 M] instrumentation cable IP 67, NEMA 6</p>  <p>25 ft. x 0.2-in. dia. [7.5 M x 5 mm dia.] 24 AWG, shielded</p>																																											
<p>5</p> <p>100-ft. [30 M] waterproof cable IP 67, NEMA 4X**, 6</p>  <p>100 ft. x 0.4-in. dia. [30 M x 10 mm dia.] 18 AWG, type SJTW</p>	<p>6</p> <p>10-ft. [3 M] pressure tested* waterproof cable IP 68, NEMA 4X**, 6P</p>  <p>10 ft. x 0.4-in. dia. [3 M x 10 mm dia.] 18 AWG, type SJTW</p>	<p>7</p> <p>100-ft. [30 M] pressure tested* waterproof cable IP 68, NEMA 4X**, 6P</p>  <p>100 ft. x 0.4-in. dia. [30 M x 10 mm dia.] 18 AWG, type SJTW</p>																																												
<p>6-pin Mating Plug</p> <table border="1"> <thead> <tr> <th>pin</th> <th>standard</th> <th>bridge</th> </tr> </thead> <tbody> <tr> <td>A</td> <td>+ in</td> <td>+ in</td> </tr> <tr> <td>B</td> <td>common</td> <td>- in</td> </tr> <tr> <td>C</td> <td>+ out</td> <td>- out</td> </tr> <tr> <td>D</td> <td>-</td> <td>+ out</td> </tr> </tbody> </table>  <p>contact view</p>		pin	standard	bridge	A	+ in	+ in	B	common	- in	C	+ out	- out	D	-	+ out	<p>Waterproof Cable</p> <table border="1"> <thead> <tr> <th>color code</th> <th>standard</th> <th>bridge</th> </tr> </thead> <tbody> <tr> <td>WHITE</td> <td>+ in</td> <td>n/a</td> </tr> <tr> <td>BLACK</td> <td>common</td> <td>n/a</td> </tr> <tr> <td>GREEN</td> <td>+ out</td> <td>n/a</td> </tr> </tbody> </table>		color code	standard	bridge	WHITE	+ in	n/a	BLACK	common	n/a	GREEN	+ out	n/a	<p>Instrumentation Cable</p> <table border="1"> <thead> <tr> <th>color code</th> <th>standard</th> <th>bridge</th> </tr> </thead> <tbody> <tr> <td>RED</td> <td>+ in</td> <td>+ in</td> </tr> <tr> <td>BLACK</td> <td>common</td> <td>- in</td> </tr> <tr> <td>GREEN</td> <td>+ out</td> <td>+ out</td> </tr> <tr> <td>WHITE</td> <td>-</td> <td>- out</td> </tr> </tbody> </table>	color code	standard	bridge	RED	+ in	+ in	BLACK	common	- in	GREEN	+ out	+ out	WHITE	-	- out
pin	standard	bridge																																												
A	+ in	+ in																																												
B	common	- in																																												
C	+ out	- out																																												
D	-	+ out																																												
color code	standard	bridge																																												
WHITE	+ in	n/a																																												
BLACK	common	n/a																																												
GREEN	+ out	n/a																																												
color code	standard	bridge																																												
RED	+ in	+ in																																												
BLACK	common	- in																																												
GREEN	+ out	+ out																																												
WHITE	-	- out																																												

*-Test pressure: 100 feet [30 meters] H₂O (40 PSID); Test Medium: Air; Duration: 2 hours. **-Applies to stainless steel enclosure only.